

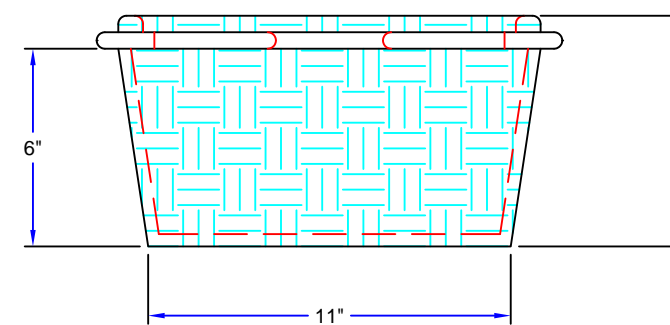

NOTES:

- OVERALL TOLERANCE IS +/- .125" UNLESS NOTED OTHERWISE

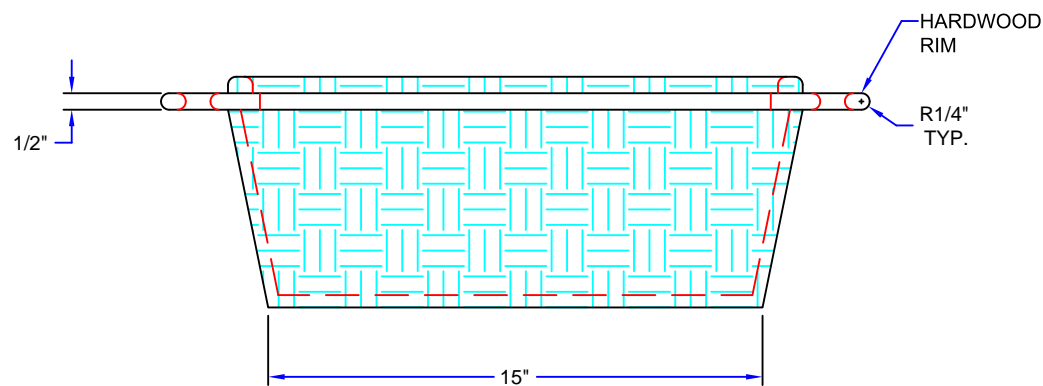

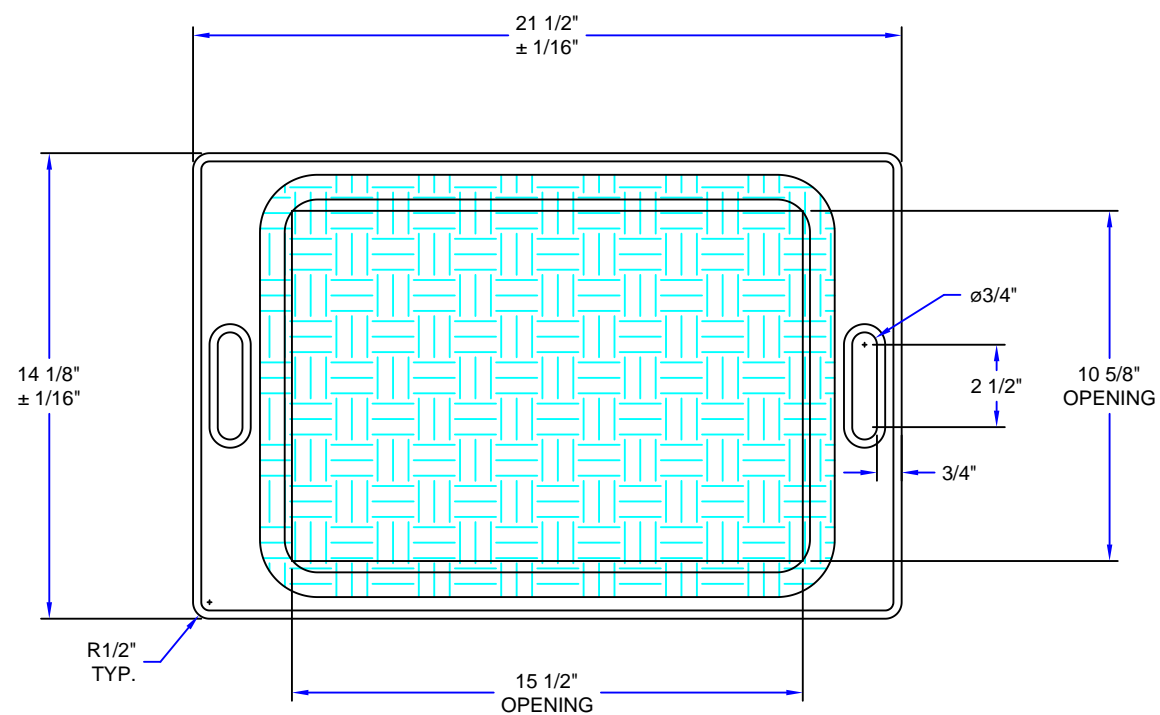



MFG. INITIALS:				
LAYOUT:				
BREAK:				
WELDER:				
POLISHER:				
CRATING:				
REV:	BY:	DATE:	DESCRIPTION:	
REVISION HISTORY:				

APPROVED
APPROVED AS NOTED
REVISE & RESUBMIT

 APPROVED BY

 DATE

John BOOS
 Since 1887
 3601 SOUTH BANKER STREET
 P.O. BOX 609
 EFFINGHAM, IL. 62401
 (217) 347-7701 / FAX (217) 347-7705
 E-MAIL: sales@johnboos.com
 Web Site: www.johnboos.com



 SANITATION

THIS DRAWING AND THE DESIGN SHOWN ARE THE PROPERTY OF JOHN BOOS & CO. REPRODUCTION, INFRINGEMENT OR ANY OTHER UNAUTHORIZED USE OF THIS DRAWING WITHOUT THE WRITTEN CONSENT OF JOHN BOOS & CO. WILL BE SUBJECT TO LEGAL ACTION.

QUOTE NUMBER:	JOHN BOOS & CO.			
DATE: 8/09/18	WICKER BASKET			
SCALE: 2"=1'	SHEET NUMBER:	QUANTITY:	DECK MATERIAL:	BASE MATERIAL:
DRAWN BY: TN	QUAD LOCATION:	ITEM NUMBER:	MODEL NUMBER: DWB11156	
REQUESTED BY:	ROOM NUMBER:	WEIGHT:	SALES ORDER NUMBER:	

NOTES:

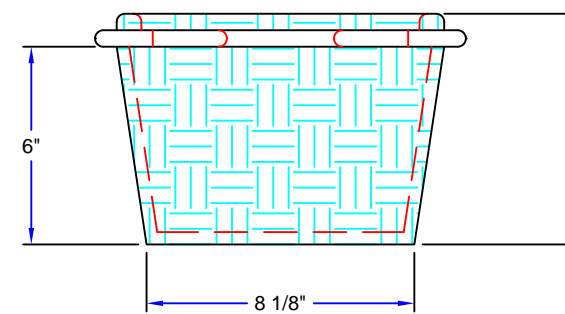
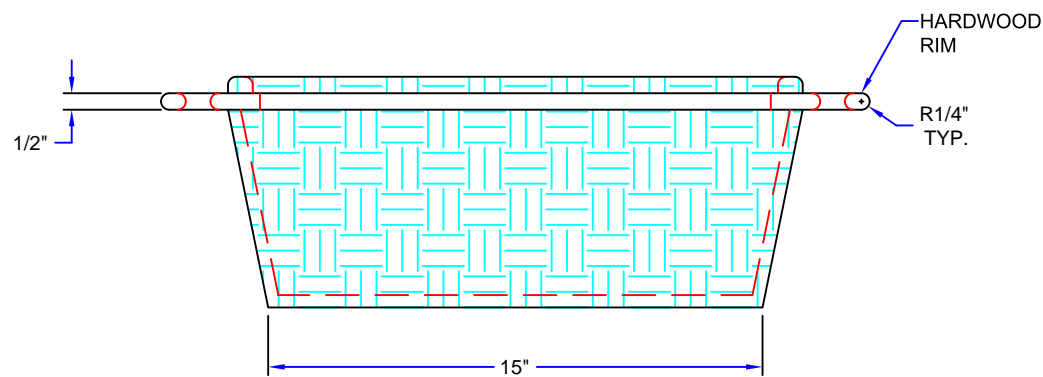
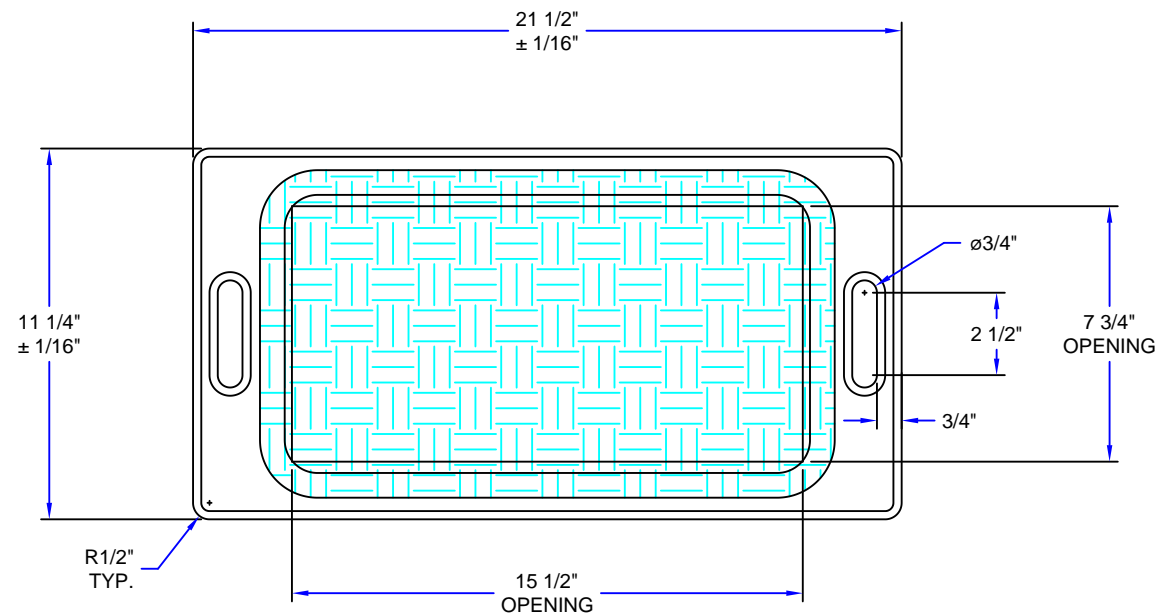
- OVERALL TOLERANCE IS +/- .125" UNLESS NOTED OTHERWISE



MFG. INITIALS:				
LAYOUT:				
BREAK:				
WELDER:				
POLISHER:				
CRATING:				
REV:	BY:	DATE:	DESCRIPTION:	
REVISION HISTORY:				

APPROVED
APPROVED AS NOTED
REVISE & RESUBMIT

 APPROVED BY

 DATE

 John BOOS
 Since 1887
 3601 SOUTH BANKER STREET
 P.O. BOX 609
 EFFINGHAM, IL. 62401
 (217) 347-7701 / FAX (217) 347-7705
 E-MAIL: sales@johnboos.com
 Web Site: www.johnboos.com



QUOTE NUMBER:	JOHN BOOS & CO.			
DATE: 8/09/18	WICKER BASKET			
SCALE: 2"=1'	SHEET NUMBER:	QUANTITY:	DECK MATERIAL:	BASE MATERIAL:
DRAWN BY: TN	QUAD LOCATION:	ITEM NUMBER:	MODEL NUMBER: DWB8156	
REQUESTED BY:	ROOM NUMBER:	WEIGHT:	SALES ORDER NUMBER:	